

Burner systems:

- G45-16/19(N,P)A-SS
- G45-18/20(N,P)A-SS
- G45-24(N,P)A-SS
- G45-30(N,P)A-SS
- G45-36(N,P)A-SS

Regulated burner system for use with propane or natural gas



DESIGN CERTIFIED to

- ANSI Z21.60-2012
- CSA 2.26-2012
- ANSI Z21.97-2012
- CSA 2.41-2012
- CAN/CGA-2.17-M87

**FOR INSTALLATION IN
SOLID-FUEL BURNING
FIREPLACES**

G45 STAINLESS STEEL BURNER FOR INDOOR OR OUTDOOR USE

Important: Read this manual carefully before starting installation of the log set.

WARNING

If the information in this manual is not followed exactly, a fire or explosion may result, causing property damage, personal injury, or loss of life.

Do not store or use gasoline or other flammable vapors and liquids in the vicinity of this or any other appliance.

An LP-cylinder shall not be stored in the vicinity of this or any other appliance.

WHAT TO DO IF YOU SMELL GAS:

- Do not try to light any appliance.
- Do not touch any electrical switch; do not use any phone in the building.
- Immediately call the gas supplier from a neighbor's phone and follow the gas supplier's instructions.
- If you cannot reach the gas supplier, call the fire department.

Installation and service must be performed by an NFI Certified or other qualified professional installer, service agency, or the gas supplier.

The installation of appliances designed for manufactured home (U.S. only) or mobile home installation must conform with the Standard CAN/CSA Z240 MH, Mobile Housing, in Canada, or with the Manufactured Home Construction and Safety Standard, Title 24 CFR, Part 3280, in the United States, or when such a standard is not applicable, ANSI/NCSCBS A225.1/NFPA 501A, Manufactured Home Installations Standard.

CODE AND SUPPLY REQUIREMENTS

The installation and the provisions for combustion and ventilation air must conform with local codes and ordinances, or in the absence of local codes, with the latest *National Fuel Gas Code, ANSI Z223.1/NFPA 54*, the *Natural Gas and Propane Installation Code, CSA B149.1*, or *International Fuel Gas Code*.

⚠ WARNING

Improper installation, adjustment, alteration, service, or maintenance can cause injury or property damage. Read the installation, operating and maintenance instructions thoroughly before installing or servicing this equipment.

This appliance is designed as an **attended appliance**. Adults **must** be present when the unit is operating. **DO NOT** leave this unit burning when unattended. If this product is left burning unattended it may cause damage or serious injury.

INSTALLER: Leave this manual with the appliance.
CONSUMER: Retain this manual for future reference.



Systèmes de brûleur:

G45-16/19(N,P)A-SS
 G45-18/20(N,P)A-SS
 G45-24(N,P)A-SS
 G45-30(N,P)A-SS
 G45-36(N,P)A-SS

Système réglé de
 brûleur pour l'usage
 avec du propane et le
 gaz naturel



Certifié à:

ANSI Z21.60-2012
 CSA 2.26-2012
 ANSI Z21.97-2012
 CSA 2.41-2012
 CAN/CGA-2.17-M87

**POUR L'INSTALLATION EN
 CHEMINÉES BRÛLANTES
 DE COMBUSTIBLE
 SOLIDE***

BRÛLEUR À L'ACIER INOXYDABLE G45 POUR L'USAGE D'INTÉRIEUR OU EXTÉRIEUR

Lisez ce manuel soigneusement avant de commencer l'installation de l'ensemble de notation.

AVERTISSEMENT

Si l'information en ce manuel n'est pas suivie exactement, une incendie ou une explosion peut résulter, entraînant des dégâts matériels, le dommage corporel, ou des pertes humaines.

Ne stockez pas ou n'employez l'essence ou d'autres vapeurs et liquides inflammables à proximité de ceci ou d'aucun autre appareil.

Un LP-cylindre ne sera stocké à proximité de ceci ou d'aucun autre appareil.

CE QUI À FAIRE SI VOUS SENTEZ LE GAZ:

- N'essayez pas de n'allumer aucun appareil.
- Ne touchez aucun commutateur électrique ; n'utilisez aucun téléphone dans le bâtiment.
- Appelez immédiatement le fournisseur de gaz du téléphone d'un voisin et suivez les instructions du fournisseur de gaz.
- Si vous ne pouvez pas atteindre le fournisseur de gaz, appelez les corps de sapeurs-pompiers.

L'installation et le service doivent être assurés par un NFI certifié ou tout autre installateur professionnel qualifié, agence de service, ou le fournisseur de gaz.

L'installation des appareils conçus pour la maison manufacturée (États-Unis seulement) ou l'installation de caravane résidentielle doit se conformer au CAN/CSA standard Z240 MH, logement mobile, au Canada, ou à la construction et au standard de sécurité à la maison manufacturés, intitulent 24 CFR, la partie 3280, aux Etats-Unis, ou quand une telle norme ne s'applique pas, à ANSI/NCSBCS A225.1/NFPA 501A, installations à la maison manufacturées standard.

CODEZ ET FOURNISSEZ LES CONDITIONS

Ce brûleur extérieur doit être installé selon des codes locaux et des ordonnances, ou en l'absence des codes locaux, avec le plus défunt code national de gaz de carburant, la norme ANSI Z223.1/NFPA 54, le code d'installation de gaz naturel et de propane, CSA B149.1, ou code international de gaz de carburant.

⚠ AVERTISSEMENT

L'installation, l'ajustement, le changement, le service, ou l'entretien inexact peuvent causer des dommages ou des dégâts matériels. Lisez l'installation, l'opération et les instructions d'entretien complètement avant d'installer ou entretenir cet équipement.

Cet appareil est conçu comme appareil occupé. Les adultes doivent être présent quand l'unité fonctionne. Ne laissez pas ce burning d'unité si sans surveillance. Si ce produit est laissé sans surveillance brûlant il peut causer des dommages ou des dommages sérieux.

INSTALLATEUR: Laissez ce manuel avec l'appareil.
CONSOMMATEUR: Maintenez pour la future référence.

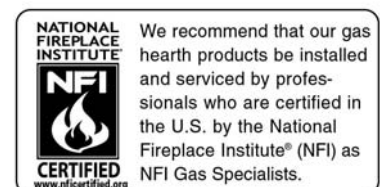

TABLE OF CONTENTS

SAFETY INFORMATION	3
PARTS LIST	4
BEFORE YOU BEGIN - IMPORTANT INFORMATION	5
INSTALLATION	6
INSTALLING THE BURNER	6
GRANULE, EMBER, AND GRATE PLACEMENT	7
LOG PLACEMENT	7
OPTIONAL CHARRED SERIES INSTALLATION	9
NOTES PAGE	10
OPERATING THE LOG SET - LIGHTING AND EXTINGUISHING	11
TECHNICAL DATA AND SPECIFICATION INFORMATION	13
TROUBLESHOOTING THE GAS LOG SET	14
WARRANTY	16

SAFETY INFORMATION

- 1. Children and adults should be alerted to the hazards of high surface temperatures and should stay away to avoid burns or clothing ignition.**
- 2. Young children should be carefully supervised when they are in the area of the appliance.**
- 3. Clothing or other flammable materials should not be placed on or near the appliance.**
- 4. Any guard or other protective device removed for servicing the appliance must be replaced prior to operating the appliance.**
- 5. Installation and repair must be done by a qualified professional service person. The appliance must be inspected before use and at least annually by a qualified professional service person. More frequent cleaning may be required as necessary.**
- 6. Solid fuels shall not be burned in a fireplace where this gas log set is installed.**
- 7. Keep the appliance area clear and free from combustible materials, gasoline and other flammable vapors and liquids.**
- 8. The burner assembly must be replaced prior to the appliance being put into operation if it is evident that the burner assembly is damaged. Contact your local dealer for replacement parts.**
- 9. A fireplace screen must be in place when the system is burning. Provisions for adequate combustion air must be maintained. Unless other provisions for combustion air are provided, the screen shall have an opening(s) for introduction of combustion air. Combustion air is adequate when all flames curl into the fireplace and away from the screen. When a glass fireplace enclosure (door) is used, leave the doors fully open when the system is in operation.**

PARTS LIST

Before beginning installation, be sure the gas log set is complete by comparing its contents with this PARTS LIST. The Golden Oak log set is listed and illustrated. The parts may differ depending upon the log style and size of the set. Be sure you know the model number and size of your set when ordering replacement or optional parts and accessories.

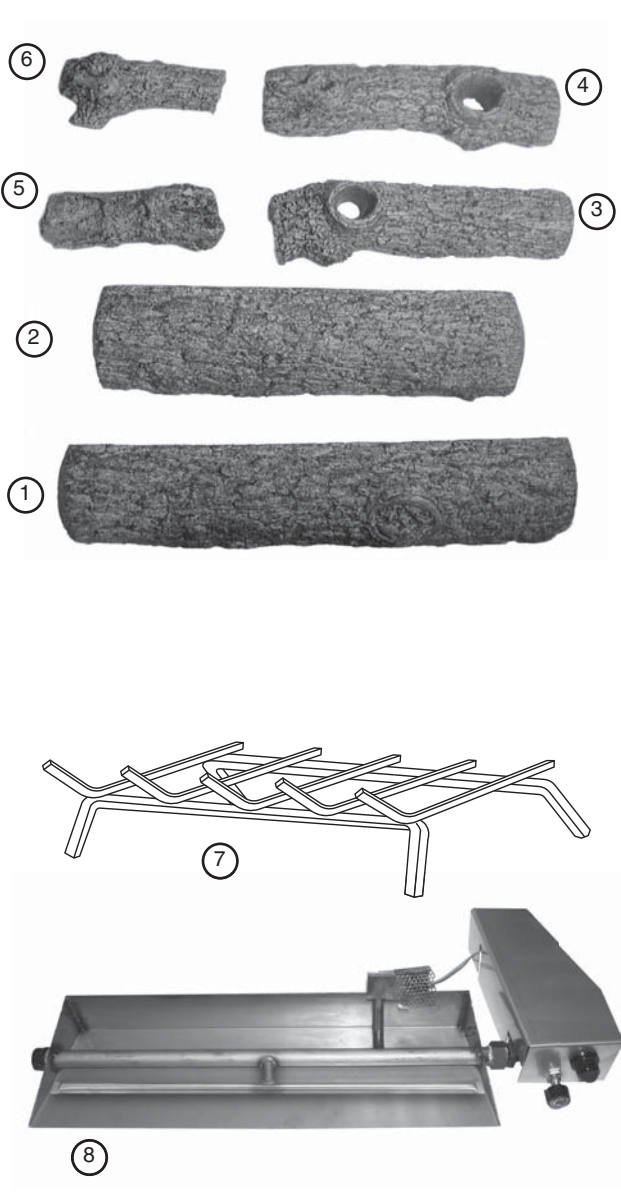

Replacement parts can be ordered from your local dealer.



ITEM#	DESCRIPTION
1.	Golden Oak front bottom log
2.	Golden Oak Rear bottom log
3.	Golden Oak top log
4.	Golden Oak top log
5.	Golden Oak top log
6.	Golden Oak top log
7.	Fireplace grate

ITEM#	DESCRIPTION
8.	Burner pan and valve assembly
9.	Connector kit (with adapter)
10.	Real-Fyre® glowing embers
11.	Sand granules (natural gas only)
or	Lava granules (propane gas only)
12.	Damper clamp
13.	(2) Stabilizer clips

BEFORE YOU BEGIN - IMPORTANT INFORMATION

Before You Begin, review the information and safeguards below about the installation and operation of the Real-Fyre® gas log set.

Check to be sure that the fireplace meets the venting and construction requirements for the installation of the Real-Fyre® gas log set.

THIS BURNER IS DESIGNED FOR USE WITH PROPANE OR NATURAL GAS. Never use natural gas in a log set designed for use with propane gas and never use propane gas in a burner designed for natural gas.

This product is not recommended for use in temperatures below 32°F.

Be sure the gas log set is properly sized for the fireplace. Improper sizing may negatively impact the proper drafting of the fireplace. Additionally, too large a log set will adversely affect the burn and hamper the proper operation of the control system. Too small a log set will diminish the beauty of the hearth setting. Fig. 5-1 illustrates the critical dimensions of the firebox.

This gas log set must be installed by an NFI Certified or other qualified professional installer. The Real-Fyre® gas log set is to be installed only in a solid-fuel burning fireplace with a working flue and constructed of noncombustible material. The fireplace must have an open damper. The chimney must be free of any obstructions.

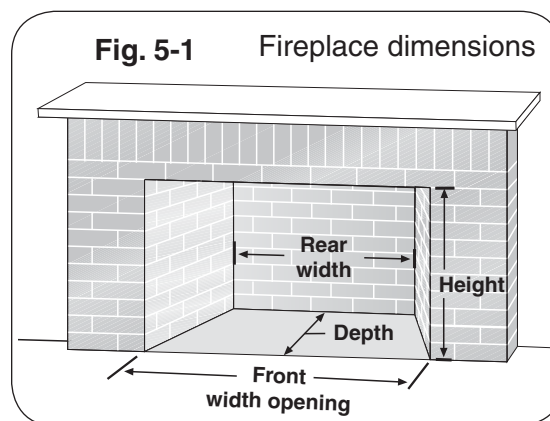

The fireplace must have a gas supply line that has been installed by a qualified technician in accordance with all local codes. The gas supply line must have a ½" minimum interior diameter. If the gas line to the fireplace is longer than 20', a larger diameter line may be necessary.

Be sure to clean the fireplace floor of any ashes or other foreign materials. It is recommended that the fireplace and chimney be examined and cleaned by a chimney sweep or other qualified person before you install the Real-Fyre® gas log set, and annually thereafter.

Required Gas Pressure: The minimum inlet gas-supply pressure for the purpose of input adjustment is 5" for natural gas and 10" for propane gas. The maximum inlet gas-supply pressure for this burner is 10.5" for natural gas and 13" for propane gas.

Testing the Gas Supply System: The gas log set and its individual shut-off valve must be disconnected from the gas supply piping system while performing any tests of the piping system at pressures in excess of ½ psig (3.5 kPa). The gas log set must be isolated from the gas supply piping system by closing its individual manual shut-off valve during any pressure testing of the gas supply piping system at test pressures equal to or less than ½ psig (3.5 kPa). This is accomplished by closing the gas supply line valve, which is required by NFPA 54, section 5.54.

Burner size	Min. Fireplace Dimensions				BTU	
	Width		Depth	Height	NAT.	L.P.
	Front*	Rear				
16/19"	29"	23"	11"	18"	40k	30k
18/20"	30"	24"	14"	18"	70k	45k
24"	34"	28"	14"	18"	90k	65k
30"	40"	34"	15"	18"	95k	75k
36"	46"	40"	16"	18"	95k	75k

* This required width allows for centering of the log set.

Note: Rear width is at corresponding depth.

Minimum Free Opening Area of Chimney Damper for Venting (sq. in.)					
For Factory-Built Fireplaces *					
Chimney Height	16/19"	18/20"	24"	30"	36"
15' (min.)	25	44	57	60	60
20'	23	40	51	54	54
30'	20	36	46	48	48

* For Masonry-Built Fireplaces; add 4 sq. in. to amount shown.

Important: For safe operation and proper performance of this product and to comply with certification, listings, and building code acceptances, use ONLY Peterson Real-Fyre® controls, parts, and accessories that have been specifically listed or certified for use with this burner system. Use of other controls, parts, or accessories is prohibited and will void all warranties, certifications, listings, and building code approvals, and may cause property damage, personal injury, and loss of life.

INSTALLATION

The damper clamp with hex bolt (Fig. 6-1) is provided as a means to prevent full closure of the damper blade. The clamp is easily attached to most damper blades with pliers or a wrench, and must be permanently installed. The clamp is designed to prevent accidental closure of the damper when installed as illustrated (Fig. 6-2 and Fig. 6-3). Should the clamp not fit, or fail to provide the permanent vent opening listed in the table found above, have a permanent stop installed, remove the damper blade, or have the damper cut to provide the minimum permanent opening required.

Note: These are minimum damper opening specifications. The damper must be completely opened when operating this gas appliance to achieve the best ventilation possible.

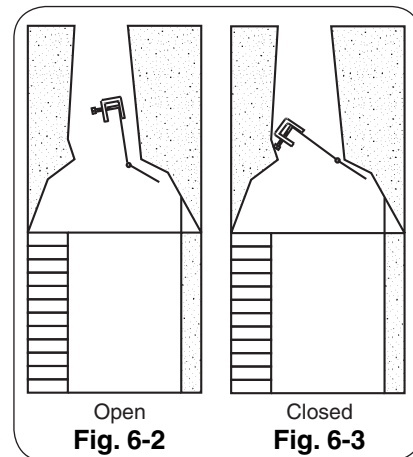
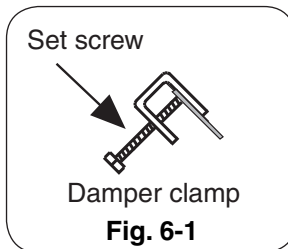

INSTALLING THE BURNER

The Real-Fyre gas log set must be installed by a qualified professional service technician. Instructions must be followed carefully to ensure proper performance and full benefit from the gas log set. **Check to be sure the log set is designed and labeled for the type of gas (natural or propane gas) supplied to the fireplace.** Fireplace floor must be level, clean, and smooth.

WARNING: Failure to position the parts in accordance with these diagrams or failure to use only parts specifically approved with this appliance may result in property damage or personal injury.

REFER TO THE PARTS LIST WHEN FOLLOWING THESE INSTRUCTIONS.

1. MAKE SURE THE FIREPLACE GAS SUPPLY IS TURNED OFF.
2. Locate the gas-supply stub inside the fireplace and remove the cap, if attached (see Fig. 6-4).

CAUTION: When removing the cap, make sure the stub does not turn, loosening the connection inside the wall.

3. Attach the nut end of the flex connector (Item 9) to the adapter found on the regulator behind the valve. Tighten securely.
4. Place the burner system into the fireplace so the open burner pan faces outward.
5. Locate the grate (Item 7) and attach the stabilizer clips (Item 13) to the 2 outer bars of the grate with screws and nuts. The stabilizer clips should be positioned towards the middle of the bars (Fig. 6-5). Place a clip on each side of the bar, insert the screw, attach the nut, and loosely tighten. Repeat for the other side.
6. Place the grate over the burner pan so the stabilizer clips fit over the back edge of the burner pan to lock it in position. Completely tighten the clips in place.
7. Center this assembly in the fireplace and place it as far back in the fireplace as possible. Remove the grate for the gas connection and granule/ember placement.

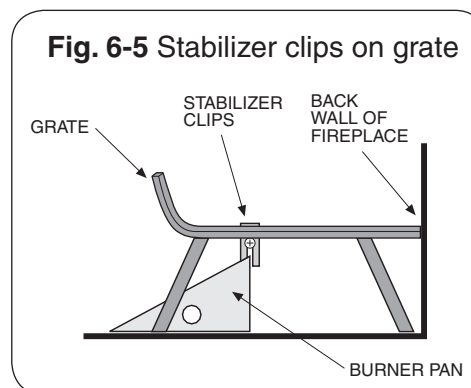
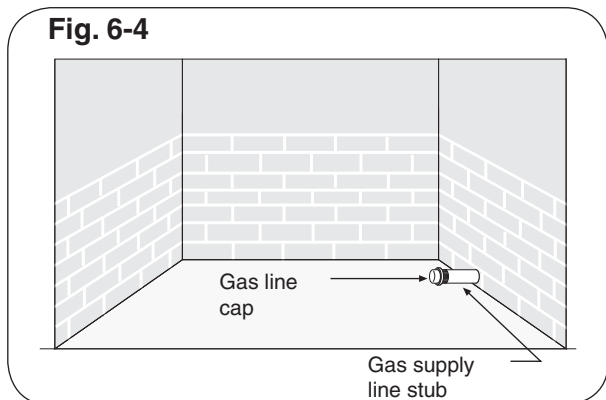

INSTALLATION (cont.)

8. **Be sure gas to the fireplace is off.** Attach the large adapter end of the flex connector (Item 9) to the gas-supply stub using a pipe compound resistant to all gases. Ensure adapter (and nut) are tightened securely. Ensure the pan rests level on the fireplace floor after connection. Adjust the pan if necessary.
9. **LEAK TEST:** Turn on the fireplace gas supply, and test at all connections for leaks using the appropriate soapy water solution. If bubbles appear, a leak is present. Turn off the gas and tighten at all connections. Repeat until no leaks are present. If a leak persists, turn off the gas supply and contact the local gas company or dealer. **NEVER USE A FLAME TO CHECK FOR LEAKS.**

Turn off the gas supply prior to proceeding.

Important: Heatshields must be in place during operation of the gas log set. Overheating of the valve will cause shut down of the gas log set or other operating problems.

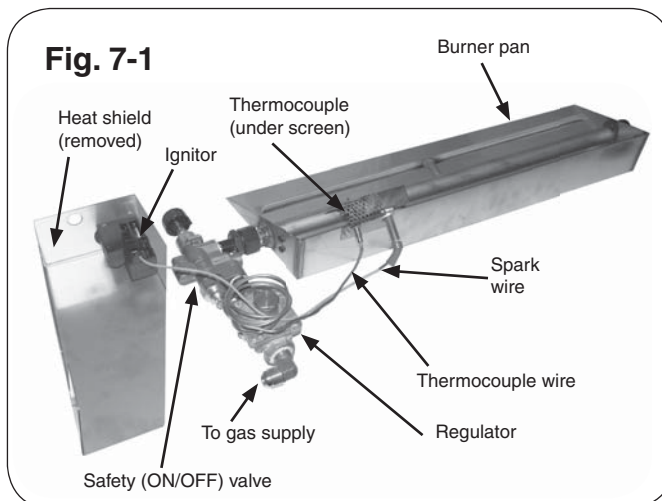

GRANULE, EMBER, AND GRATE PLACEMENT

GRANULE PLACEMENT

The granules supplied with the unit are specially selected for use with either propane gas or natural gas. They maximize flame distribution and reduce carbon buildup.

1. Fill the burner pan completely with the granules* (Item 11). See Fig. 7-2. **Avoid spilling the granules on the pilot kit.**

Note: Use only select sand for natural gas burners and lava granules for propane gas burners.

2. Slope the granules at the same angle as the burner pan. This is important to ensure quiet lighting and even flame distribution.
3. Pour a small amount of the granules along the outside edges of the burner pan (Fig. 7-2). This prevents flame diversion.

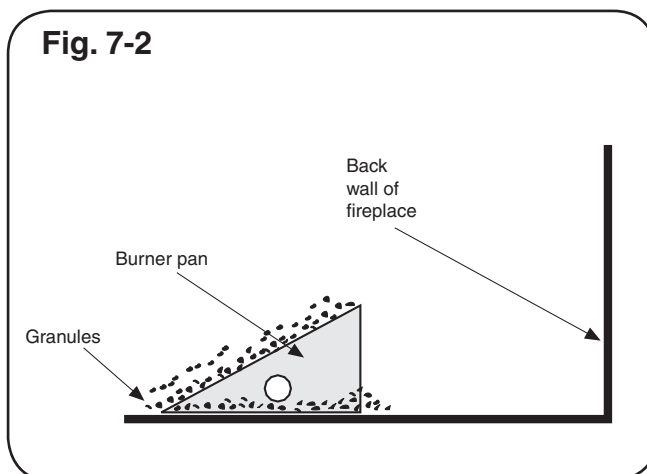

EMBER PLACEMENT

Sprinkle the glowing embers (Item 10) lightly and evenly over the entire surface of the granules (in the pan only). **Break up any clumps that may have developed during shipment.** (For Charred series log sets, refer to OPTIONAL CHARRED SERIES INSTALLATION section.)

Important: Do not add any additional embers to this log set. Any additional embers may cause unsafe operation.

GRATE PLACEMENT

Replace the grate so that the stabilizer clips fit over the back edge of the pan, locking it in position.

LOG PLACEMENT

CAUTION: Burn hazard. Logs will remain hot for some time after use. You must maintain the log layout as shown to ensure proper operation of your log set. If you need to reposition any log to maintain the proper layout, use heat-resistant gloves or allow logs adequate time to cool before handling.

Styles and sizes will vary depending upon the log set ordered. If the log set ordered includes placement instructions; follow those instructions.

LOG PLACEMENT (cont.)

NOTE: LOGS SUPPLIED SEPARATELY.

Log placement is very important for the proper operation of the Real-Fyre® gas log set. Although you have some flexibility in the log arrangement, it is necessary to follow the LOG PLACEMENT instructions carefully to fully enjoy your log set. Follow the steps below, referring to Fig. 8-1 through Fig. 8-5.

1. The second-longest log, the rear log, is placed on the rear of the grate with the bark of the log facing forward (Fig. 8-1). Center the log left to right (Fig. 8-5, #1).
2. The longest log, the front log, is placed on the front of the grate with the bark facing forward. Center left to right (Fig. 8-2, #2). **NOTE: Be sure to maintain a space between the front and rear logs** (Fig. 8-1).
3. Top logs should be stacked diagonally, with the largest at the bottom (Fig. 8-3, #3 & 4), and with spaces between the logs so that the flames are not choked off. Place the smaller logs diagonally across the larger ones (see Fig. 8-4, #5 & #6). The top logs may be moved to achieve desired flame pattern. Some carbon buildup (sooting) may occur where the flames impinge on the logs and should not be a concern unless excessive. If sooting is excessive, rearrange the top logs to reduce flame impingement. Examples of log stacks are shown below.

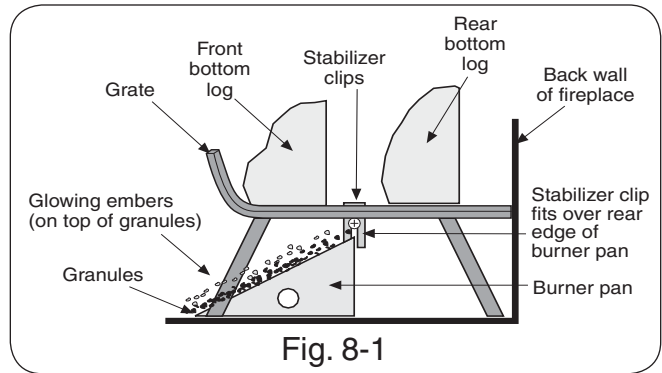

Note: Although log styles may differ in pattern or shape (Fig. 8-6), layout is essentially the same. Adequate spacing between the logs is NECESSARY and MUST be maintained for best performance.

STEP 1. Place the second-longest log to the rear.

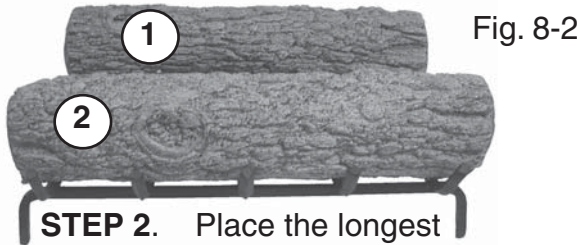

STEP 2. Place the longest log at the front.

STEP 3. Place the largest top logs across the bottom logs.



Knotholes go to the front or back as desired.



Alternative examples of log layout (Split Oak set shown). Note the space between the logs.

STEP 3 (cont.) Place the smaller top logs across the other logs.

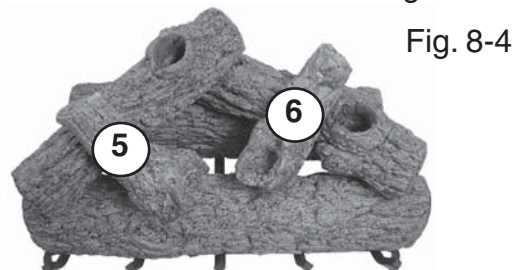

(Note the gaps between the logs.)

Note: 24" Golden Oak (R-24) shown



Royal English Oak Designer

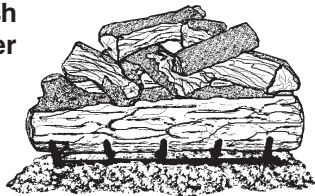

Split Oak Designer Plus

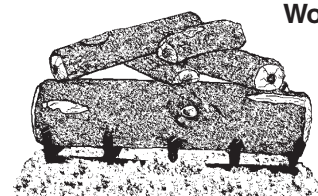

Woodland Oak

Fig. 8-6 - Recommended log patterns

OPTIONAL CHARRED SERIES INSTALLATION

GLOWING EMBERS PLACEMENT

Note: Optional Charred Series log sets are supplied with an ember screen (Fig. 9-1).

Attach the ember screen to the burner by slipping it onto the back edge (center left to right) with the perforated section facing toward the back fireplace wall (Fig. 9-1). Cover the surface of the ember screen with the Glowing Embers (Fig. 9-2). For best glowing performance, they should be applied evenly and pulled slightly apart so the fibers are somewhat loose. (It is not necessary to pile the entire bag of the Glowing Embers. More Glowing Embers may be added after completion of the entire installation).

Fig. 9-1

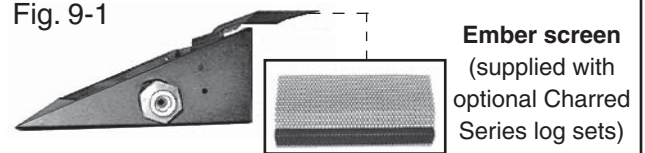
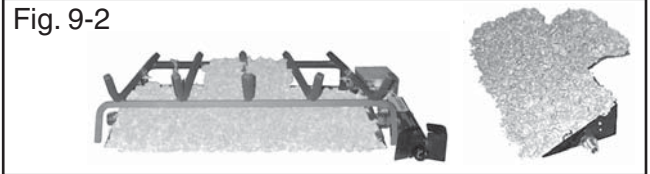

Fig. 9-2



LOG PLACEMENT

Log styles and sizes will vary depending upon the Charred Series log set ordered.

CHARRED SPLIT (CHS) layout shown.

Place the long bottom rear log (Log #2) on the back of the grate with the flat featureless side facing the rear of the fireplace. The two sections of the front log (Logs #1A & 1B) are placed on the front of the grate with the charred sections facing each other and approximately 1 inch apart at the top (Fig. 9-3). Slide the logs to the front of the grate.

Note: Be sure to maintain a space between the front and rear logs (Fig. 9-3).

Place the two curved logs (Logs #3 & 4) so that one end rests on each front log section (Logs #1A & 1B) and the other end rests on the rear log (Log #2). The charred sections should be over the opening between the front and rear logs (Fig. 9-4).

Place the small top charred logs (Logs #5 & 6) so they rest over the charred sections of the front bottom log sections (Logs #1A & 1B) and on the two curved logs (Logs #3 & 4) (Fig. 9-5).

Finally, place the curved top charred log (Log #7) to rest on the two top logs at rear, but not encroaching into the space between rear and front logs (Fig. 9-6).

Note: The additional top log (Log #7) is not available with 18" log sets.

Fig. 9-3



Fig. 9-4

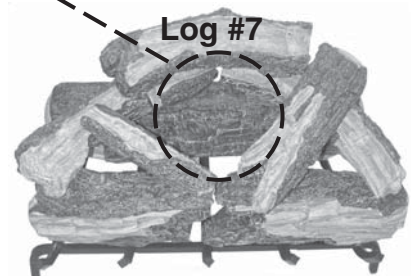

Fig. 9-5



MAINTAIN A SPACE IN THE CENTER OF THE LOGS AT ALL TIMES

Fig. 9-6



Please use this page to record any information about your burner system that you may want to have at hand.

OPERATING THE LOG SET - LIGHTING AND EXTINGUISHING

FOR YOUR SAFETY, READ BEFORE LIGHTING

WARNING: If you do not follow these instructions exactly, a fire or explosion may result, causing property damage, personal injury, or loss of life.

- A. BEFORE LIGHTING**, smell all around the gas log set area for gas. Be sure to smell next to the floor because some gas is heavier than air and will settle on the floor.
- B. IF YOU SMELL GAS:**
- **Shut off the gas to the appliance.**
 - **Extinguish any open flame.**
 - **If odor continues, keep away from the appliance, and immediately call the gas supplier or fire department.**
- C.** Use only your hand to push in or turn the gas control knob. Never use tools. If the knob will not push in or turn by hand, don't try to repair it. Call a qualified service technician. Force or attempted repair may result in fire or explosion.
- D.** Do not use the gas log set if any part has been underwater. Immediately call a qualified service technician to inspect the gas log set and to replace any part of the control system and any gas control that has been underwater.

LIGHTING THE GAS LOG SET

1. After you have finished checking for leaks, ensure that the unit is turned completely off by pushing in the ON/OFF control knob and turning clockwise toward **OFF** until you reach a stop.
2. Turn the ON/OFF control knob counter-clockwise to the **ON** position. **DO NOT PUSH KNOB IN!**

Note: You should not hear or smell any gas at this point.

3. Wait five (5) minutes to clear out any gas. Smell for gas, including near the floor. If you smell gas, stop and follow step B of the safety information above. If you don't smell gas, go to the next step.

4. LIGHTING INSTRUCTIONS

- a. Press and hold in the electronic ignitor button. The ignitor will spark with a rapid clicking noise.
- b. While holding in the electronic ignitor, push in the ON/OFF control knob to open the valve. Burner will now ignite at the maximum BTU input.
- c. Continue to hold knob for 10-15 seconds; this will allow the safety valve to activate and the main burner to remain burning.

Note: Electronic igniter may not properly operate when exposed to high moisture. To manually light the burner, lay a long-stem match on the surface of the embers near the gas inlet (**do not hold the match in your hand**) or use a lighted long necked butane lighter.

TURNING OFF THE GAS LOG SET

1. Push in the ON/OFF control knob and turn clockwise toward **OFF** until you reach a stop (burner will extinguish).

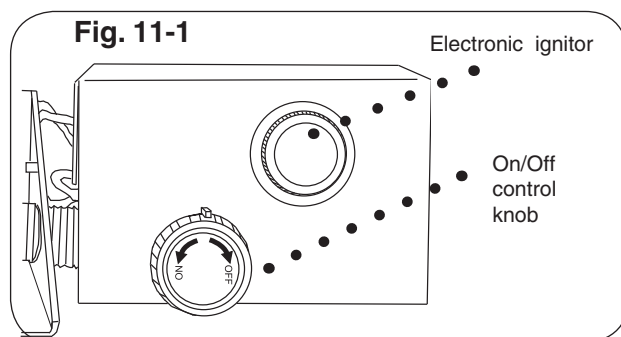

POUR VOTRE SÛRETÉ, LISEZ AVANT L'ALLUMAGE

AVERTISSEMENT: Si vous ne suivez pas ces instructions exactement, une incendie ou une explosion peut résulter, entraînant des dégâts matériels, le dommage corporel, ou des pertes humaines.

- A. AVANT L'ALLUMAGE**, sentez tous autour du secteur réglé de notation de gaz pour le gaz. Soyez sûr de sentir à côté du plancher parce qu'un certain gaz est plus lourd que l'air et arrangez sur le plancher.
- B. SI VOUS SENTEZ LE GAZ:**
- Coupez le gaz à l'appareil
 - Éteignez-vous n'importe quelle flamme nue.
 - Si l'odeur continue, gardez à partir de l'appareil, et appelez immédiatement le fournisseur ou les corps de sapeurs-pompiers de gaz.
- C.** Utilisez seulement votre main pour enfoncer ou pour tourner le bouton de commande de gaz. N'utilisez jamais les outils. Si le bouton n'enfoncera pas ou ne tournera pas à la main, n'essayez pas de le réparer. Appelez un technicien qualifié de service. La force ou la réparation essayée peut avoir comme conséquence l'incendie ou l'explosion.
- D.** N'employez pas la notation de gaz réglée si n'importe quelle partie a été sous-marine. Appelez immédiatement un technicien qualifié de service pour inspecter l'ensemble de notation de gaz et pour remplacer n'importe quelle partie du système de contrôle et de n'importe quelle commande de gaz qui a été sous-marine.

ALLUMAGE DE L'ENSEMBLE DE NOTATION DE GAZ

1. Après que vous ayez fini la vérification les fuites, assurez-vous que l'unité est arrêtée complètement en enfonçant le bouton de commande "MARCHE/ARRÊT" et en tournant dans le sens des aiguilles d'une montre vers AU LOIN jusqu'à ce que vous atteigniez un arrêt.
2. Tournez le bouton de commande "MARCHE/ARRÊT" dans le sens contraire des aiguilles d'une montre à la position de fonctionnement. **NE PUSSEZ PAS LE BOUTON DEDANS!**

Note: Vous ne devriez entendre ou sentir aucun gaz en ce moment.

3. Attendez cinq (5) minutes pour dégager dehors n'importe quel gaz. Sentez pour le gaz, y compris près du plancher. Si vous sentez le gaz, arrêtez et suivez l'étape B d'information de sûreté ci-dessus. Si vous ne sentez pas le gaz, passez à la prochaine étape.

4. INSTRUCTIONS D'ÉCLAIRAGE

- a. Pressez et tenez dans le bouton électronique d'allumeur. L'allumeur étincellera avec un bruit cliquant sur rapide.
- b. Tout en se tenant dans l'allumeur électronique, enfoncez le bouton de commande "MARCHE/ARRÊT" pour ouvrir la valve. Le brûleur mettra à feu maintenant à l'entrée de Btu de maximum.
- c. Continuez à tenir le bouton pendant 10-15 secondes; ceci permettra à la soupape de sûreté d'activer et au brûleur principal de rester brûlant.

Note: La bougie électronique peut correctement ne pas fonctionner une fois exposée à l'humidité élevée. Pour allumer manuellement le brûleur, étendez une allumette de long-tige sur la surface des braises près de l'admission de gaz (ne tenez pas l'allumette dans votre main) ou employez un long allumeur étranglé allumé de butane.

ARRÊTER L'ENSEMBLE DE NOTATION DE GAZ

1. Enfoncez le bouton de commande "MARCHE/ARRÊT" et tournez dans le sens des aiguilles d'une montre vers AU LOIN jusqu'à ce que vous atteigniez un arrêt (le brûleur s'éteindra).

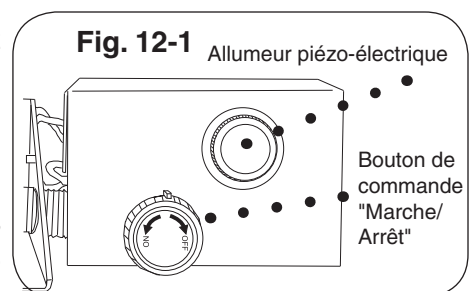

MAINTENANCE

Once installed and operating properly, the Real-Fyre® gas log set requires very little maintenance. You should inspect the log set and control annually for the following:

- 1. Excessive sooting** - Some sooting of the log set is normal and adds to the appearance of burned wood. If sooting accumulates, you may brush the soot off with a stiff brush. Do not use water or soot cleaners to clean off the soot.
- 2. Settling of glowing embers and granules** - Moisture may cause the granules and glowing embers in the burner pan to settle and affect the burn. Using a screwdriver or flat blade knife, carefully stir the granules and embers, loosening the materials.
- 3. Debris around the control** - Inspect the control to be sure it is free of any dirt or debris.

SERVICE

While some minor service conditions may be handled by the owner of the log set, it is recommended that a qualified service technician be called to service the gas log set and control should service be required. The TROUBLESHOOTING section of these instructions serves as a guide for ensuring optimum performance of the gas log set.

FLAME DESCRIPTION

Observe the flames. The main burner flames should be blue at the base and a combination of blue/yellow at the body and at the tips. They should be 5" to 8" above the logs, with the center flame being the tallest (see cover photo). Flames in the ember burner should be 1/4" above the embers.

To adjust the flame pattern, take a long blade screwdriver or similar tool and stir the granules until the desired pattern is achieved. **DO NOT REMOVE GRANULES FROM THE BURNER PAN**

Long bladed screwdriver
(or similar)

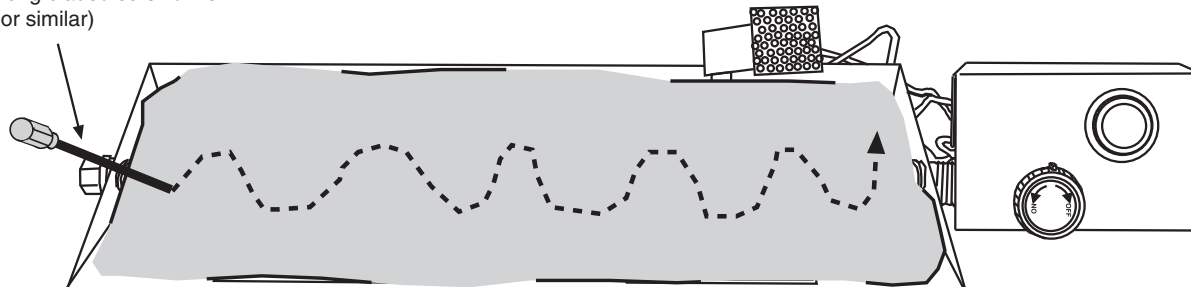

Insert blade into granules and stir in various places until desired flame pattern is achieved.

TROUBLESHOOTING THE GAS LOG SET

SYMPTOM	CAUSE	SOLUTION
<p>1. Excessive smoking and sooting</p> <p>Note: Like burning natural firewood, the Real-Fyre® gas log set is designed to burn with a yellow smoky flame. Some sooting is common and desirable.</p>	A. Poor draft or down draft	A. Check for chimney blockage. Be sure chimney is at least 3' taller than anything within 10' of it in all directions. If not, consult a chimney sweep. Chimney cap or fan may help. Under severe conditions, you may need to open a window near the fireplace about 1" to 2" when burning the log set.
	B. Improper set for gas used	B. Use only a natural gas set with natural gas. Use only a propane gas set with propane gas.
	C. Damper closed	C. Open damper fully when operating gas log set.
	D. Set is positioned too close to the front of the firebox	D. Move set so that the back of the grate touches the back wall of the firebox.
	E. Improper log placement	E. Be sure the bottom logs are spaced at least 3" apart. Top logs should be placed to minimize flame impingement.
	F. Air mixer on propane set is closed	F. Open air mixer completely.
<p>2. Low flame</p>	A. Incorrect log set size for burner system	A. Consult the dealer for proper set.
	B. Insufficient gas supply	B. Other gas appliances may be competing for gas supply. Consult installer or plumber. Orifice size is based upon 7" w.c. pressure for natural gas and 11" w.c. pressure propane gas. Plumbing must supply adequate pressure.
	C. Blockage or kink in connector kit, plumbing or burner orifice	C. Clean out blockage. If connector kit is kinked, replace it.
	D. Valve not fully open	D. Open valve fully.

TROUBLESHOOTING THE GAS LOG SET (cont.)

SYMPTOM	CAUSE	SOLUTION
3. Uneven flame distribution (Lower at one end of the burner)	A. Clogged or blocked portholes	A. Portholes can be cleared of foreign object by running a wire through them.
	B. Insufficient gas pressure and/or supply	B. Consult installer or plumber (see solution 2b).
	C. Granules may be packed down too tightly or not evenly	C. Loosen granules around burner pipe by running a kitchen knife along both sides of pipe. Even out granules in burner pan.
	D. Auxiliary shut-off valve partially closed	D. Open valve fully. Usually, you will find this along the wall 3' from the fireplace.
	E. Valve not fully open	E. Open valve fully.
4. Flame backing out of air mixer (propane)	A. Clogged or blocked portholes	A. Portholes can be cleared of foreign object by running a wire through them.
	B. Insufficient gas pressure and/or supply	B. Consult installer or plumber (see solution 2b).
	C. Granules may be packed down too tightly	C. Loosen granules around the burner by running a kitchen knife along both sides of the pipe. Be sure lava granules are used.
	D. Excessive gas pressure	D. Contact the gas supplier.

WARRANTY

PETERSON VENTED DECORATIVE GAS APPLIANCE LIMITED WARRANTY

Robert H. Peterson Co. ("RHP") warrants your Real Fyre® vented decorative gas appliance to be free from defects in material and workmanship.

Peterson vented ceramic refractory gas logs are warranted for **as long as you own them (lifetime)**.

Peterson vented burner assemblies are **WARRANTED for TEN (10) YEARS**. Peterson vented outdoor stainless-steel burner assemblies are warranted for **FIVE (5) YEARS**.

Peterson glass, gems, nuggets, and fiber-ceramic blend gas logs are warranted for **FIVE (5) YEARS**.

SPK-26 controls are warranted for **THREE (3) YEARS**.

APK-17 controls (including -17 valve) are warranted for **TWO (2) YEARS**.

All other Peterson valves, pilots, and controls are warranted for **ONE (1) YEAR (excluding batteries)**.

A COPY OF YOUR SALES SLIP FOR PROOF OF PURCHASE IS REQUIRED

This warranty applies to the original purchaser for products which are installed in the United States or Canada and which are operated and maintained as intended for single family residential usage. This warranty is valid only with proof of purchase, shall commence on the date of purchase, and shall terminate (both as to original and any replacement products) on the anniversary date of the original purchase of the product stated on the above schedules.

This warranty covers defects in material and workmanship. This warranty **does not** cover parts which become defective as a result of negligence, misuse, use not in compliance with the Owner's Manual/Installation Instructions, accidental damage, improper handling, improper storage, improper installation, lack of required routine maintenance (as specified in the Owner's Manual/Installation Instructions), electrical damage, local gas impurities or failure to protect against combustibles. Product must be installed (and gas must be connected) as specified in the Owner's Manual/Installation Instructions by a **qualified professional installer**. Modifications to products which are not specifically authorized will void this warranty. Accessories, parts, valves, remotes, etc. when used must be Peterson products or this warranty is void. Warranted items will be repaired or replaced at Peterson's sole discretion. This warranty **does not** apply to rust, corrosion, oxidation, or discoloration unless the affected part becomes inoperable.

This warranty **does not** cover labor or labor related charges, except as provided by separate specific written programs from the Peterson Co. All repair work must be performed by a qualified professional service person and requires prior approval of Peterson.

Peterson may require the defective product or part to be returned to the factory to determine the cause of failure. Peterson will pay freight charges if the product or part is determined to be defective. This warranty does not cover breakage in shipment from our (Independent) distributor to its customer if the damage is determined to have occurred during that shipment.

This warranty specifically excludes liability for **indirect, incidental, or consequential** damages. Some states and provinces do not allow the exclusion or limitation of incidental or consequential damages, so the above exclusion may not apply to you. This warranty gives you specified legal rights, and you may have other rights that vary from state to state or province.

For additional information regarding this warranty, or to place a warranty claim, contact the R. H. Peterson dealer where the product was purchased.

**TO REGISTER YOUR PRODUCT ONLINE GO TO: WWW.RHPETERSON.COM,
AND CLICK ON PRODUCT REGISTRATION. THANK YOU FOR YOUR PURCHASE.**

FOR USE IN THE COMMONWEALTH OF MASSACHUSETTS

**INSTALLATION OF THIS APPLIANCE MUST BE PERFORMED BY A MASSACHUSETTS
LICENSED PLUMBER OR GAS FITTER ONLY.**

**CONNECTOR KITS USED FOR INSTALLATION AND OPERATION OF THIS APPLIANCE
MUST NOT BE MORE THAN 36" IN LENGTH.**

**FIREPLACE DAMPER MUST BE REMOVED OR PERMANENTLY FIXED/WELDED IN FULL
OPEN POSITION PRIOR TO INSTALLING THIS PRODUCT.**

Quality Check

Date: _____

Burner Orifices	Nat.	L.P.	Leak Test:	_____	Model#:	_____
Main:	_____	_____	Burn Test:	_____	Serial#:	_____
Other:	_____	_____	Gas Type:	Nat. / L.P.	Air Shutter:	_____
					Inspector:	_____